



- Zones 1/21 and 2/22
- Chemical resistance
- Wide range of sizes

Polyester enclosures have proven their worth in many industrial plants. They offer safe protection even when they are used under extremely unfavorable conditions, on exposure to aggressive chemical media or hard mechanical conditions. The inside base of the enclosure has at its sides, threaded bushings for the fastening of mounting rails or panels. The enclosure is mounted by means of insulated screws outside of the lid seal.

Explosion protection

Ex enclosure black Type 07-5185-..../....	
Marking ATEX	⊕ II 2G Ex eb IIC Gb ⊕ II 2D Ex tb IIIC Db IP 66
Certification	PTB 08 ATEX 1062 U
Marking IECEx	Ex eb IIC Gb Ex tb IIIC Db IP 66
Certification	IECEx PTB 09.0008U
Ex enclosure grey Type 07-5184-..../....	
Marking ATEX	⊕ II 2G Ex eb IIC Gb
Certification	PTB 08 ATEX 1062 U
Marking IECEx	Ex eb IIC Gb
Certification	IECEx PTB 09.0008U
Other approvals and certificates, see www.bartec.com	

Technical data

Material	glass-fiber reinforced polyester, EN 60079-0, halogen-free black surface resistance < 10 ⁹ Ω grey surface resistance > 10 ¹² Ω
Colour	black: RAL 9005 grey: RAL 7000/RAL 7001
Lid screws	stainless steel cross-head (+ -) (other models on request)
Standard seal	EPDM -20 °C to +95 °C optional Silicone -55 °C to +100 °C
Mechanical resistance	impact energy 7 Nm (EN/IEC 60079-0)
Protection class	IP 66 EN/IEC 60529

Ordering information Empty enclosure

External dimensions (L x B x H) mm	Polyester black, IP 66 Order no.	Polyester grey, IP 66 Order no.
80 x 75 x 55	07-5195-0800/7555	07-5194-0800/7555
110 x 75 x 55	07-5195-1100/7555	07-5194-1100/7555
160 x 75 x 55	07-5195-1600/7555	07-5194-1600/7555
190 x 75 x 55	07-5195-1900/7555	07-5194-1900/7555
122 x 120 x 90	07-5195-1221/2090	07-5194-1221/2090
122 x 120 x 120	07-5195-1221/2012	07-5194-1221/2012
220 x 120 x 90	07-5195-2201/2090	07-5194-2201/2090
160 x 160 x 90	07-5195-1601/6090	07-5194-1601/6090
160 x 160 x 120	07-5195-1601/6012	07-5194-1601/6012
260 x 160 x 90	07-5195-2601/6090	07-5194-2601/6090
360 x 160 x 90	07-5195-3601/6090	07-5194-3601/6090
560 x 160 x 90	07-5195-5601/6090	07-5194-5601/6090
200 x 250 x 120	07-5195-2002/5012	07-5194-2002/5012
255 x 250 x 120	07-5195-2552/5012	07-5194-2552/5012
255 x 250 x 160	07-5195-2552/5016	07-5194-2552/5016
400 x 250 x 120	07-5195-4002/5012	07-5194-4002/5012
400 x 250 x 160	07-5195-4002/5016	07-5194-4002/5016
400 x 405 x 120	07-5195-4004/0512	07-5194-4004/0512
400 x 405 x 165	07-5195-4004/0516	07-5194-4004/0516

Technical data subject to change without notice.

Dimensions (mm)

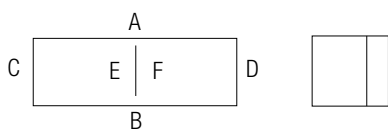

The dimensions indicated on this page apply to the following polyester enclosures and distribution boxes:

IP enclosure	black	07-5195-.../...
IP enclosure	grey	07-5194-.../...
Ex enclosure	black	07-5185-.../...
Ex enclosure	grey	07-5184-.../...
IP distribution box	black	07-5178-.../...
IP distribution box	grey	07-5177-.../...
Ex e distribution box	black	07-5103-.../...
Ex e distribution box	grey	07-5106-.../...
Ex i distribution box	black	07-5105-.../...
Ex i distribution box	grey	07-5107-.../...

Technical data

External dimensions	80 x 75 x 55 mm	
Weight	230 g	
Material	polyester, grey, black	
Article no.	07-51 □□ -0800/7555	

External dimensions	110 x 75 x 55 mm	
Weight	280 g	
Material	polyester, grey, black	
Article no.	07-51 □□ -1100/7555	

External dimensions	160 x 75 x 55 mm	
Weight	370 g	
Material	polyester, grey, black	
Article no.	07-51 □□ -1600/7555	

External dimensions	190 x 75 x 55 mm	
Weight	430 g	
Material	polyester, grey, black	
Article no.	07-51 □□ -1900/7555	

Dimensions (mm)

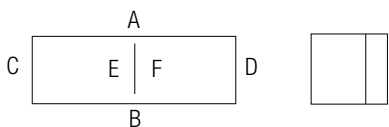

The dimensions indicated on this page apply to the following polyester enclosures and distribution boxes:

IP enclosure	black	07-5195-.../...
IP enclosure	grey	07-5194-.../...
Ex enclosure	black	07-5185-.../...
Ex enclosure	grey	07-5184-.../...
IP distribution box	black	07-5178-.../...
IP distribution box	grey	07-5177-.../...
Ex e distribution box	black	07-5103-.../...
Ex e distribution box	grey	07-5106-.../...
Ex i distribution box	black	07-5105-.../...
Ex i distribution box	grey	07-5107-.../...

Technical data

External dimensions	122 x 120 x 90 mm
Weight	660 g
Material	polyester, grey, black
Article no.	07-51 □□ -1221/2090

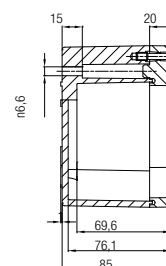
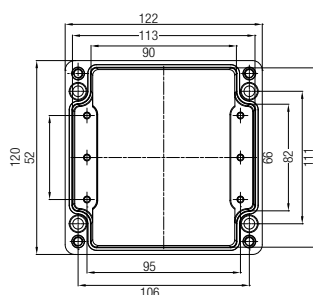

External dimensions	122 x 120 x 120 mm
Weight	890 g
Material	polyester, grey, black
Article no.	07-51 □□ -1221/2012

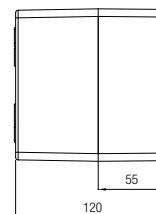
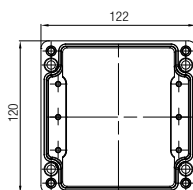

External dimensions	220 x 120 x 90 mm
Weight	1040 g
Material	polyester, grey, black
Article no.	07-51 □□ -2201/2090

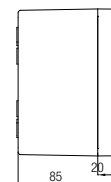
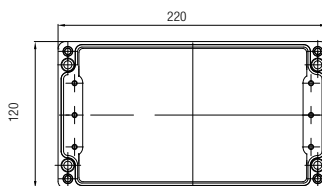

External dimensions	160 x 160 x 90 mm
Weight	1280 g
Material	polyester, grey, black
Article no.	07-51 □□ -1601/6090

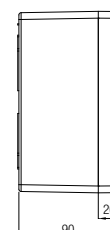
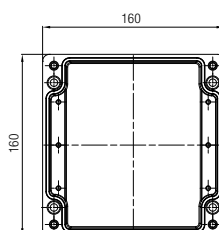

Dimensions (mm)

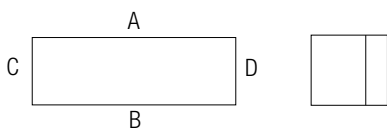

The dimensions indicated on this page apply to the following polyester enclosures and distribution boxes:

IP enclosure	black	07-5195-.../...
IP enclosure	grey	07-5194-.../...
Ex enclosure	black	07-5185-.../...
Ex enclosure	grey	07-5184-.../...
IP distribution box	black	07-5178-.../...
IP distribution box	grey	07-5177-.../...
Ex e distribution box	black	07-5103-.../...
Ex e distribution box	grey	07-5106-.../...
Ex i distribution box	black	07-5105-.../...
Ex i distribution box	grey	07-5107-.../...

Technical data

External dimensions	160 x 160 x 120 mm
Weight	1500 g
Material	polyester, grey, black
Article no.	07-51 <input type="checkbox"/> -1601/6012

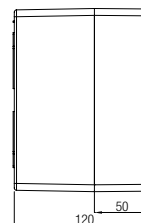
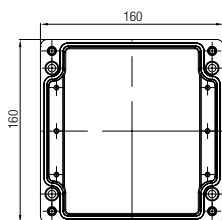

External dimensions	260 x 160 x 90 mm
Weight	1750 g
Material	polyester, grey, black
Article no.	07-51 <input type="checkbox"/> -2601/6090

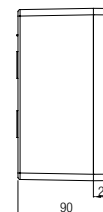
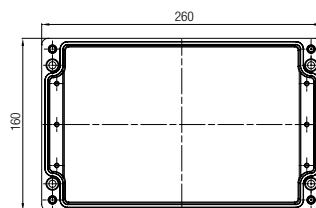

External dimensions	360 x 160 x 90 mm
Weight	2300 g
Material	polyester, grey, black
Article no.	07-51 <input type="checkbox"/> -3601/6090

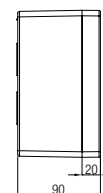
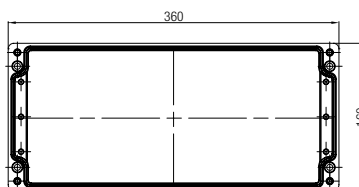

External dimensions	200 x 250 x 120 mm
Weight	2320 g
Material	polyester, grey, black
Article no.	07-51 <input type="checkbox"/> -2552/5012

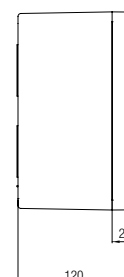
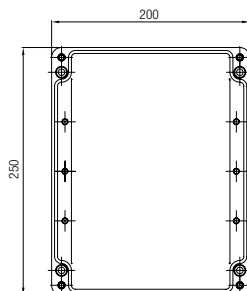

Dimensions (mm)

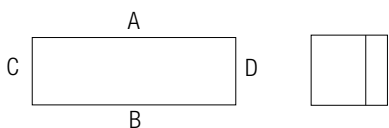

The dimensions indicated on this page apply to the following polyester enclosures and distribution boxes:

IP enclosure	black	07-5195-.../...
IP enclosure	grey	07-5194-.../...
Ex enclosure	black	07-5185-.../...
Ex enclosure	grey	07-5184-.../...
IP distribution box	black	07-5178-.../...
IP distribution box	grey	07-5177-.../...
Ex e distribution box	black	07-5103-.../...
Ex e distribution box	grey	07-5106-.../...
Ex i distribution box	black	07-5105-.../...
Ex i distribution box	grey	07-5107-.../...

Technical data

External dimensions	255 x 250 x 120 mm
Weight	2730 g
Material	polyester, grey, black
Article no.	07-51 □□ -2552/5012

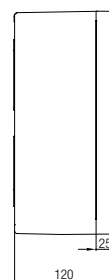
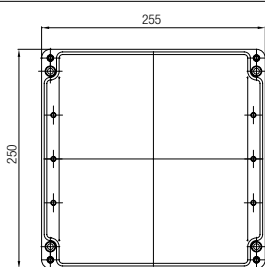

External dimensions	255 x 250 x 160 mm
Weight	3275 g
Material	polyester, grey, black
Article no.	07-51 □□ -2552/5016

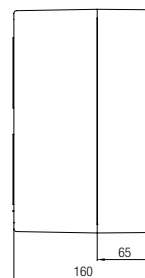
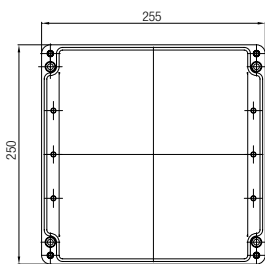

External dimensions	400 x 250 x 120 mm
Weight	3650 g
Material	polyester, grey, black
Article no.	07-51 □□ -4002/5012

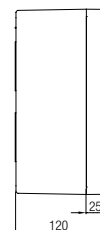
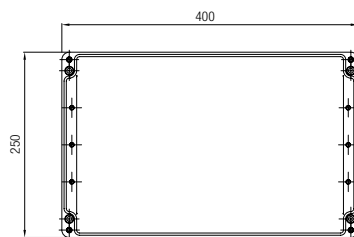

External dimensions	400 x 250 x 160 mm
Weight	4800 g
Material	polyester, grey, black
Article no.	07-51 □□ -4002/5016

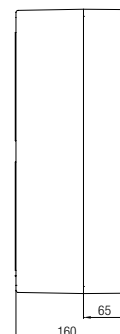
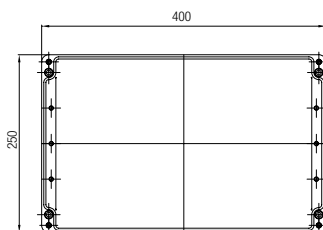

Dimensions (mm)

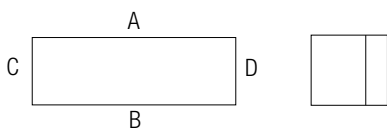

The dimensions indicated on this page apply to the following polyester enclosures and distribution boxes:

IP enclosure	black	07-5195-.../...
IP enclosure	grey	07-5194-.../...
Ex enclosure	black	07-5185-.../...
Ex enclosure	grey	07-5184-.../...
IP distribution box	black	07-5178-.../...
IP distribution box	grey	07-5177-.../...
Ex e distribution box	black	07-5103-.../...
Ex e distribution box	grey	07-5106-.../...
Ex i distribution box	black	07-5105-.../...
Ex i distribution box	grey	07-5107-.../...

Technical data

External dimensions	600 x 250 x 120 mm
Weight	5380 g
Material	polyester, grey, black
Article no.	07-51 <input type="checkbox"/> -6002/5012

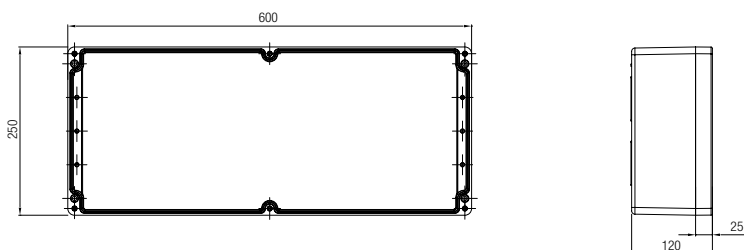

External dimensions	400 x 405 x 120 mm
Weight	5080 g
Material	polyester, grey, black
Article no.	07-51 <input type="checkbox"/> -4004/0512

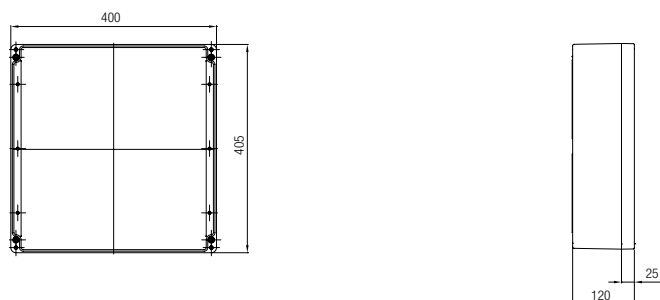

External dimensions	400 x 405 x 165 mm
Weight	7740 g
Material	polyester, grey, black
Article no.	07-51 <input type="checkbox"/> -4004/0516

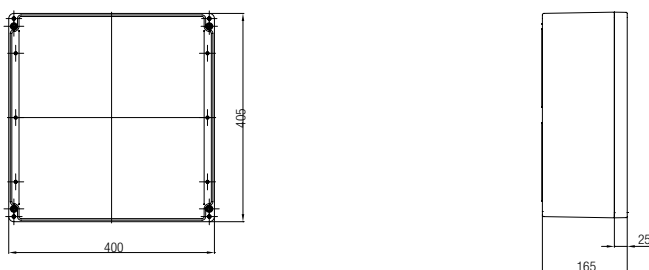

Technical data subject to change without notice.



PL 16 (Palokorvenkatu 2)
 04261 Kerava
 Puh. 010 417 4500
 hyxo@hyxo.fi • www.hyxo.fi