





-  Gas
-  Liquid & Slurry
-  Solid & Powder
-  Steam & Water

SENTRY BPRV BACK PRESSURE REGULATOR

Pressure Conditioning

SAMPLE CONDITIONING

The Sentry® BPRV relief valve holds a constant pressure of approximately 20 psig (1.4 barg) at the analyzer inlet when installed as recommended. This pressure is maintained independent of source pressure fluctuations or sample flow changes. If inlet pressure rises, the regulator opens to let excess flow pass through to drain. This flow is usually used as the grab sample. This unit also acts as a relief valve in the event of an over-pressure condition.

MODELS

BPRV

BENEFITS

When severe service pressure reduction is handled by a Sentry VREL® valve or needle valve, the BPRV only has to control pressure between 20 psig (1.4 barg) and atmosphere. This allows precise pressure control, minimizes plugging and ensures high reliability.

The Sentry BPRV has a much flatter response curve than the standard back pressure valve designed for general process applications. For example, if the set point flow rate is 1200 cc/min, a 25% change in the flow produces only a 0.2 psi (0.014 barg) change in upstream pressure, which is three times more sensitive than a standard back pressure regulator.

In normal operation, there is always a flow from the exhaust port. This flow increases with rising source pressures and decreases with falling source pressures. The BPRV also functions as a fail-safe relief valve, with a relieving capacity exceeding that of the most commonly used 1/4-inch relief valve. Since the BPRV is always in service, a malfunction is immediately evident, while a relief valve can freeze with no outward indication – until it fails to operate in an emergency.

FEATURES

- Designed specifically for power plant sample flow rates
- Most effective way to assure constant flow through online analyzers
- Less prone to plugging and sticking than a pressure-reducing valve
- Will not wire draw or erode in normal service
- Fail-safe relief valve

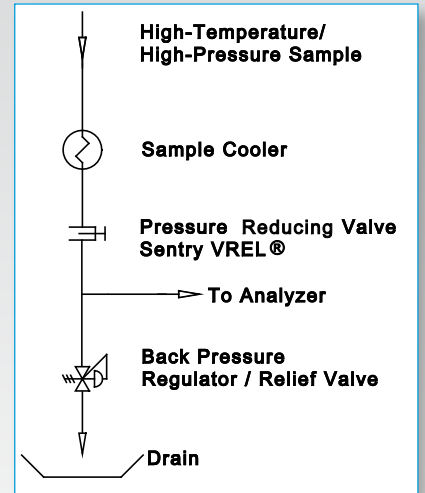
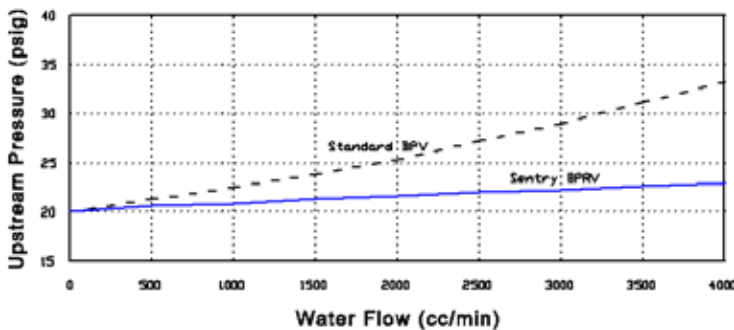

Operation

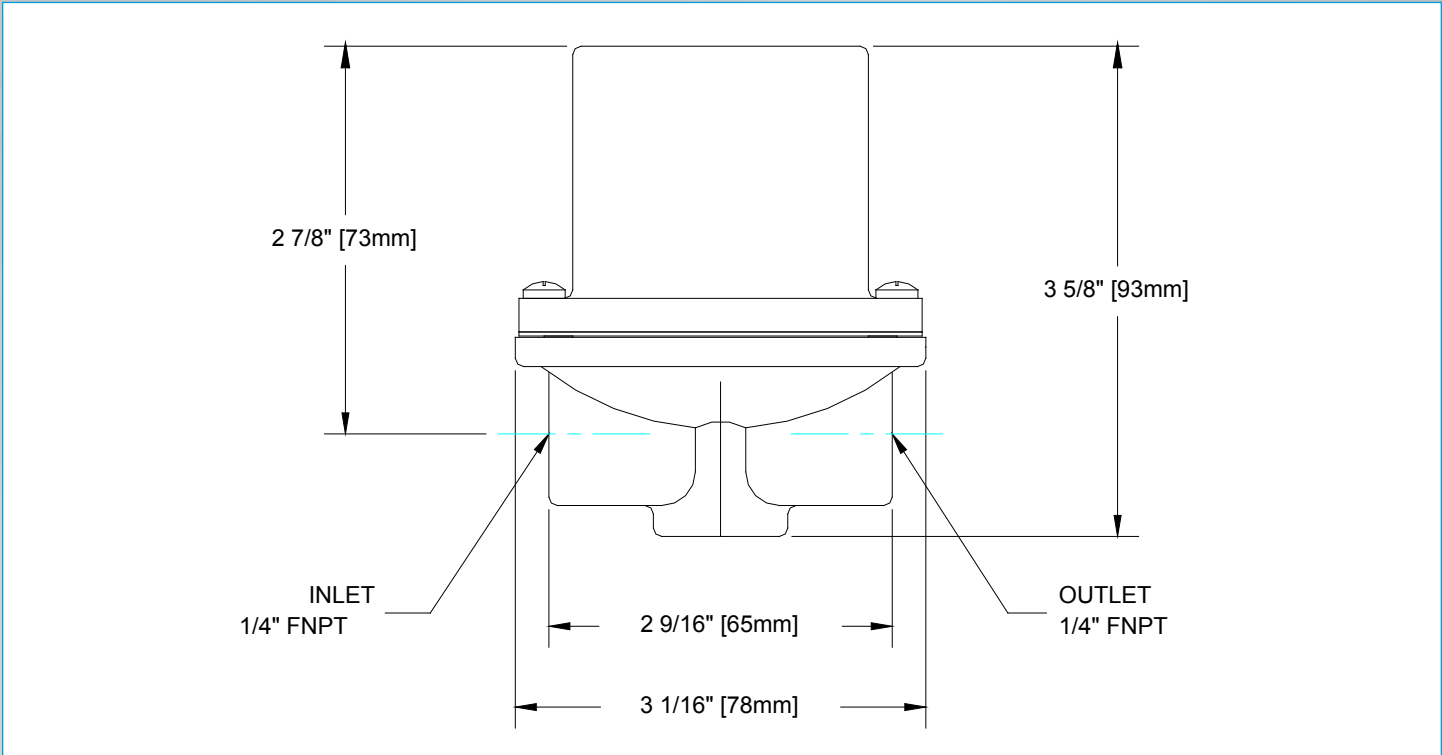

SPECIFICATIONS

weight	2 lb. (1 kg.)
wetted materials	316 stainless steel and Viton
regulated pressure	approximately 20 psig (1.4 barg) under normal operating conditions; consult company for other pressure settings
ambient temperature	-40°F to 165°F (-40°C to 74°C)
connections	1/4 in. NPT female
relieving capacity	2 gpm at 10 psi (7.6 l/min at 0.7 bar) buildup over set pressure

sentry-equip.com

966 Blue Ribbon Circle North, Oconomowoc, WI 53066 U.S.A. | +1-262-567-7256 | sales@sentry-equip.com

© 2015 Sentry Equipment Corp. All rights reserved. All product and company names are property of their respective owners. It is solely the responsibility of end users, through their own testing and analysis, to select products and materials suitable for their specific application requirements, ensure they are properly installed, safely applied and properly maintained, and to limit their use to their intended purpose. Improper selection, installation or use may result in personal injury or property damage.

S-SW-SPS-00153-15 1-17



COMPANY WITH
QUALITY SYSTEM
CERTIFIED BY DNV GL
= ISO 9001 =