

Shuttle[®] Level Transmitter



2.1



General



Shuttle® is an advanced microprocessor based ultrasonic level meter with an intelligent, precise measuring system utilizing the latest hardware and software technology. Shuttle® provides simple and logical operation, using advanced technology resulting in a high quality product at a competitive price.

Characteristics

Shuttle® is designed to measure water levels as well as other fluids and aggressive media, where the ultrasonic sensor is not in contact with the media.

- Ultrasonic measuring system with 3 sensors measuring ranges from 10 cm to 25 metres.
- *Learning*-function allows the Shuttle® Level Transmitter to learn how the tank is arranged with piping, pumps and other items that might disturb the measurement. The system also ignores turbulence and electrical interference, so even a slow moving mixer can pass through the ultrasonic beam without any influence on the measurement.
- 2 output relays for level / system alarm or pump control with duty and standby cycles.
- 4 - 20 mA output with zero and span adjustment.
- Indication of the strength of the echo signal with a bargraph.
- Very narrow ultrasonic pulse signal gives great signal strength and minimum sensitivity to foam and sludge on the surface of the liquid.
- Easy to read LCD-display for both setup and indication. Actual level is indicated with both a bargraph and with digits in millimetres, centimetres, metres, feet and inches. The digital readout can be chosen as either relative level or absolute level.
- 10 - 30 V DC or 230 / 115 V AC supply.
- FM approved sensors for hazardous areas.

Operation

Shuttle® needs no operation after initial setup. 9 function buttons behind the front panel are used to configure:

- Unit selection in either metres, centimetres, millimetres, feet and inches.
- Adjustment of zero level of the measurement and selection of relative or absolute reference.
- Zero and span for the mA output.
- Function for the two 2 output relays - off, level alarm, system alarm or pump control with alternation.
- Learning function, so the level meter recognizes how the wetwell is arranged with pumps, piping and other disturbing elements. The measurement will not be affected by false echos.



Control functions

Shuttle® is equipped with 2 output relays which can be configured for level or pump control, system alarm or level alarm. The relay function can be set to either NO or NC

contact with an optional delay function. The relays can be used for start and stop of pumps with alternation.

Application

Shuttle® is well suited for any ultrasonic level measurement. The level transmitter may also be used for measuring and control of levels in tanks with contaminated and/or aggressive media.

Shuttle® has 4 - 20 mA output increasing or decreasing with the level, where both zero level and span can be adjusted for the whole range of the sensor.

Typical applications is measurement and control in:

- stormflow tanks
- pump stations
- tanks in sewage treatment plants
- tanks in water plants
- tanks and vessels in process- and provisions industries

Electrical connections

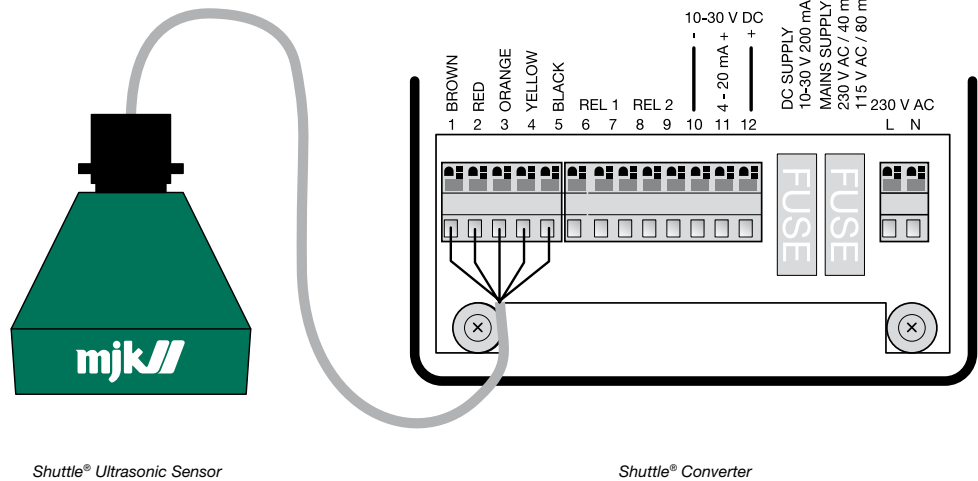

Specifications

Shuttle® Converter	
Range:	0 - 12 m, 0 - 15 m or 0 - 25 m
Span:	From 0-10 cm to 0-12 m, 0-15 m or 0-25 m
Power supply:	230 / 115 V AC ± 10 % 10 - 30 V DC
Consumption:	Approx. 2 W
Temperature:	- 20 to + 60 °C
Input:	From ultrasonic sensor
Accuracy:	Better than ± 0.2 %
Outputs:	Analog: 4 - 20 mA, max. load 500 Ω. Digital: 2 x relays with programmable NO/ NC function. Max. 50 V, 1 A resistive load.
Indication:	LCD-display with 4 digits and symbols.
Operation:	Function keypad behind front panel.
Enclosure:	IP 65
CE-approvals:	EN 50081-1, EN 50082-1 UL: File E194021

Standard range version

Shuttle® Ultrasonic Sensor 200570	
Range:	15 m (fluids) 6 m (solids)
Frequency:	30 kHz
Spread:	3 °
Deadband:	35 cm
Temperature:	- 20 to + 60 °C
Materials:	PP, POM
Cable:	Shielded, oil resistant PVC insulation, length 12 metres. (Max. 100 m. with 690010 cable.)
Enclosure:	IP 68, watertight, withstands max. 1 bar submersion.
CE-approvals:	EN 50081-1, EN 50082-1

Standard range version

Shuttle® Ultrasonic Sensor: 200640 / 200641	
	
Shuttle® Ultrasonic Sensor: 200642	
Range:	12 m (fluids), 5 m (solids)
Frequency:	40 kHz
Spread:	7 °
Deadband:	35 cm
Temperature:	- 20 to + 60 °C
Materials:	PTB, Glass reinforced Epoxy
Cable 200640:	Shielded, oil resistant PVC insulation, length 12 metres.
Cable 200641:	Shielded, oil resistant PVC insulation, length 50 metres. (Max. 100 m. with 690010 cable.)
Enclosure:	IP 68, watertight, withstands max. 1 bar submersion.
CE-approvals:	EN 50081-1, EN 50082-1
Ex-approvals:	FM Class 1, Div. 1, Groups A-G

Extended range version

Shuttle® Ultrasonic Sensor: 200630 / 200631	
	
Shuttle® Ultrasonic Sensor: 200632	
Range:	25 m (fluids), 10 m (solids)
Frequency:	30 kHz
Spread:	6 °
Deadband:	80 cm
Temperature:	- 20 to + 60 °C
Materials:	PTB, Glass reinforced Epoxy
Cable 200630:	Shielded, oil resistant PVC insulation, length 12 metres.
Cable 200631:	Shielded, oil resistant PVC insulation, length 50 metres. (Max. 100 m. with 690010 cable.)
Enclosure:	IP 68, watertight, withstands max. 1 bar submersion.
CE-approvals:	EN 50081-1, EN 50082-1
Ex-approvals:	FM Class 1, Div. 1, Groups A-G

Chemical resistant version

Shuttle® Ultrasonic Sensor: 200660	
Range:	10 m (fluids), 5 m (solids)
Frequency:	50 kHz
Spread:	6 °
Deadband:	35 cm
Temperature:	- 20 to + 60 °C
Materials:	PP, PVDF
Cable:	Shielded, oil resistant PVC insulation, length 12 metres. (Max. 100 m. with 690010 cable.)
Enclosure:	IP 68, watertight, withstands max. 1 bar submersion.
CE-approvals:	EN 50081-1, EN 50082-1

Standard range version



Ultrasonic sensor type 200570

Frequency:	30 KHz
Range:	Up to 15 m in fluids and 6 m in solids.
Directivity:	See figure below.

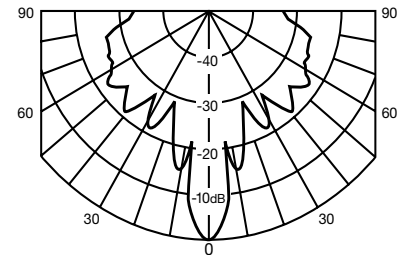

Standard range version



Ultrasonic sensor type 200640 / 200641

Ultrasonic sensor type 200642

Frequency:	40 KHz
Range:	Up to 12 m in fluids and 5 m in solids.
Directivity:	See figure below.

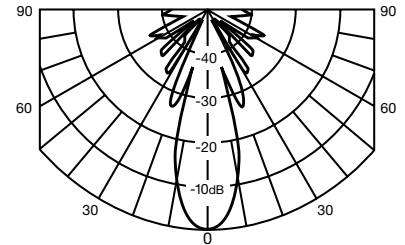

Extended range version



Ultrasonic sensor type 200630 / 200631

Ultrasonic sensor type 200632

Frequency:	30 KHz
Range:	Up to 25 m in fluids and 10 m in solids.
Directivity:	See figure below.

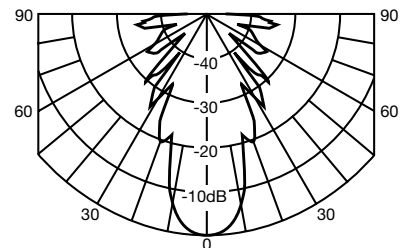

Chemical resistant version



Ultrasonic sensor type 200660

Frequency:	50 KHz
Range:	Up to 10 m in fluids and 5 m in solids.
Directivity:	See figure below.

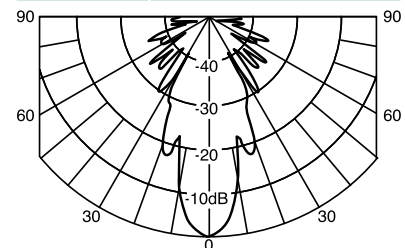

Dimensions

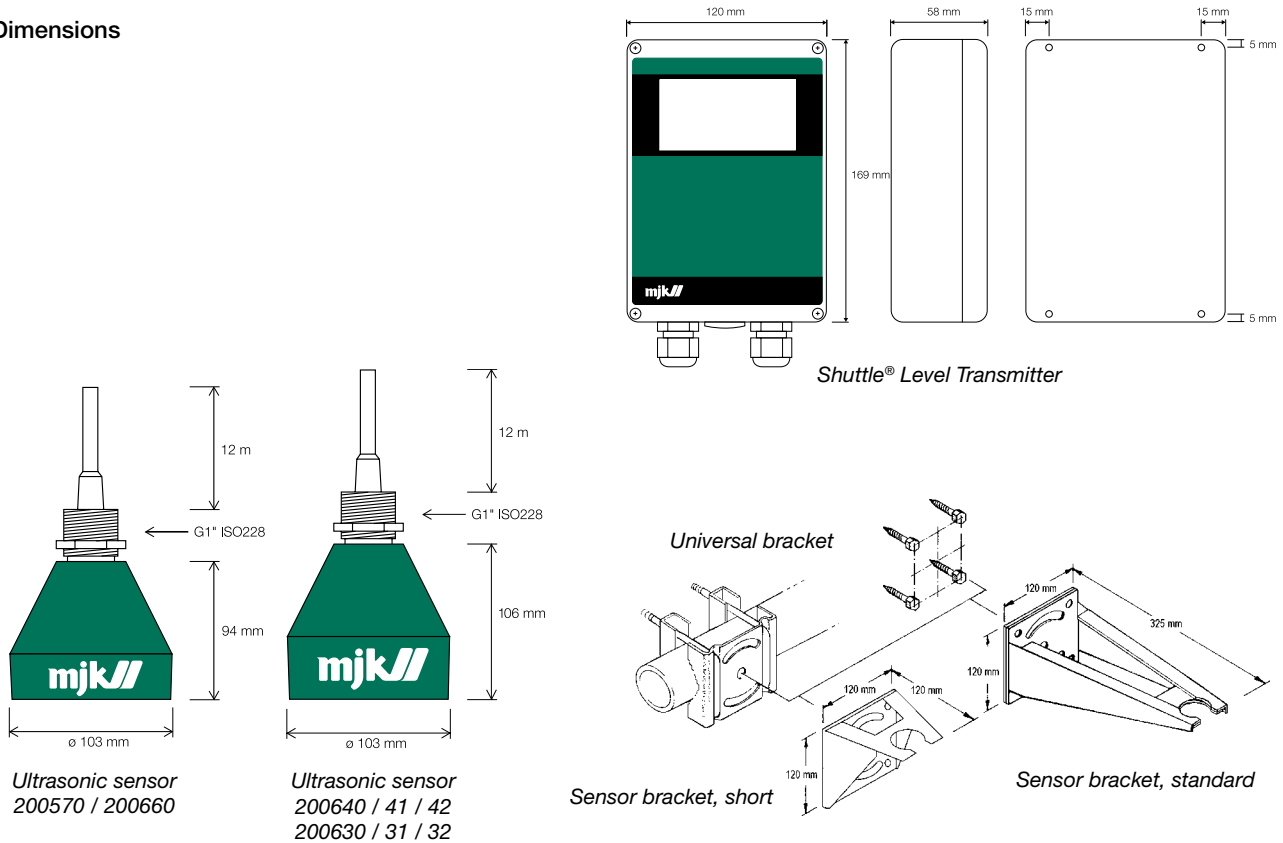

Order numbers

Shuttle® Field Level Transmitter complete with Ultrasonic Sensor	
201210	Shuttle® Level Transmitter without sensor, supply voltage 230 / 115 V AC or 10 - 30 V DC
201215	Shuttle® Level Transmitter, complete with Shuttle® Ultrasonic Sensor 200570 and 12 metres of cable, supply voltage 230 / 115 V AC or 10 - 30 V DC
201225	Shuttle® Level Transmitter, complete with Shuttle® Ultrasonic Sensor 200632 and 12 metres of cable, supply voltage 230 / 115 V AC or 10 - 30 V DC
201235	Shuttle® Level Transmitter, complete with Shuttle® Ultrasonic Sensor 200642 and 12 metres of cable, supply voltage 230 / 115 V AC or 10 - 30 V DC
201240	Shuttle® Level Transmitter, complete with Shuttle® Ultrasonic Sensor 200660 and 12 metres of cable, supply voltage 230 / 115 V AC or 10 - 30 V DC

Accessories		
200205	Universal bracket	
200219	Short sensor bracket for ultrasonic sensor	
200220	Standard sensor bracket for ultrasonic sensor	
200590	Connection box for sensor cable	
690010	Additional cable for Shuttle® Ultrasonic Sensor. Can be extended to 100 metres, specify length	
200570	Ultrasonic sensor, 30 kHz, range of 15 metres (fluids), with 12 metres of cable	FM APPROVED
200630	Ultrasonic sensor, 30 kHz, range of 25 metres (fluids), with 12 metres of cable	
200631	Ultrasonic sensor, 30 kHz, range of 25 metres (fluids), with 50 metres of cable	FM APPROVED
200632	Ultrasonic sensor, 30 kHz, range of 25 metres (fluids), with 12 metres of cable	
200640	Ultrasonic sensor, 40 kHz, range of 12 metres (fluids), with 12 metres of cable	FM APPROVED
200641	Ultrasonic sensor, 40 kHz, range of 12 metres (fluids), with 50 metres of cable	FM APPROVED
200642	Ultrasonic sensor, 40 kHz, range of 12 metres (fluids), with 12 metres of cable	
200660	Ultrasonic sensor, 50 kHz, range of 10 metres (fluids), with 12 metres of cable	
840010	Shuttle® communication software for settings incl. interface and RS 232 cable	
840011	Shuttle® communication software for settings and firmware, incl. interface and RS 232 cable	

Distributed by:

Hyxo Oy
 P.O. Box 16 (Palokorvenkatu 2)
 FI-04261 Kerava, Finland
 Tel. +358 10 417 4500
 Fax +358 10 417 4501
 hyxo@hyxo.fi • www.hyxo.com

MJK offices:

Denmark
 www.mjk.dk
 mjk@mjk.dk
 +45 46 56 06 56

Norway
 www.mjk.no
 mjk@mjk.no
 +47 69 20 60 70

The Netherlands
 www.mjk.com
 mjknl@mjk.com
 +31 251 672171

Sweden
 www.mjk.se
 kontoret@mjk.se
 +46 53 31 77 50

North America
 www.mjk.com
 mjkusa@mjk.com
 +1 847 482 8655

Australia
 www.mjk.com
 mjk@mjk.com
 +61 3 9758 8533